

API-100

User Manual



Contents

A. Components	2
<hr/>	
B. H/W Parts	
i . Both Sides	3
ii. Settings	4
iii. Battery / Light Functions	6
<hr/>	
C. System Settings	
i . Download & Install	7
ii. How to connect with the program	8
iii. Wi-Fi Combo	9
<hr/>	
D. Program Settings	12
i . Device Certification	13
<hr/>	
E. Application	
i . Start Analysis	15
ii. Full Analysis	
CRM	16
Moisture	17
Sebum	18
Pore	19
Melanin	20
Cleanliness of Pore	21
Wrinkle	22
Sensitivity	23
Summary	24
iii. View Mode	25
<hr/>	
F. Warranty	26

※ Notes on use

- The images of this manual can be different with the actual things.
- The information contained in this manual and future improvements are subject to change without notice.
- The latest version of the manual will be updated at the below link.
<http://www.aramhuvis.com/downloads>

Components

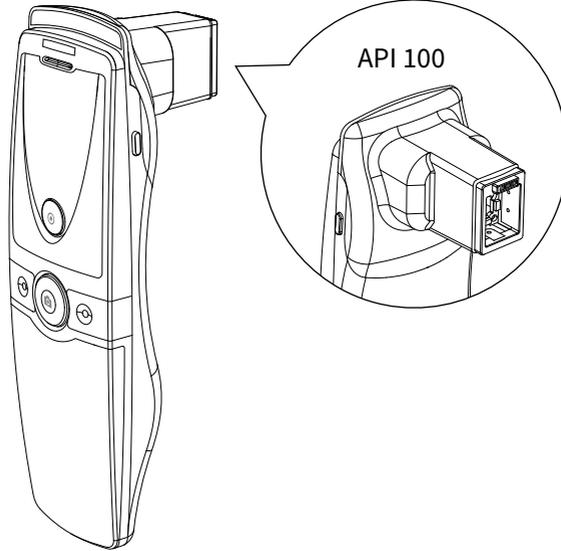

Main body with skin lens

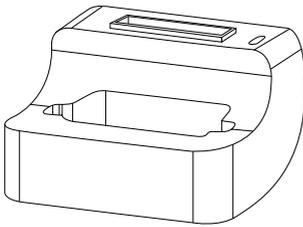

Cradle



Battery

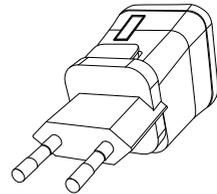

Charger

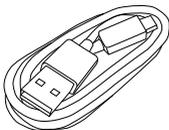

USB cable



Sebum paper 1 box

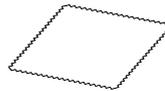

Cleaning cloth



Manual

H/W Parts

Both Sides

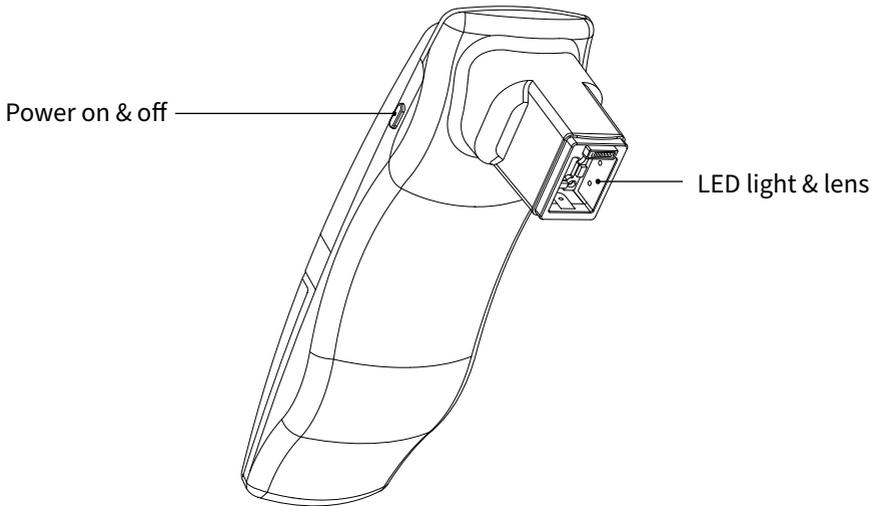
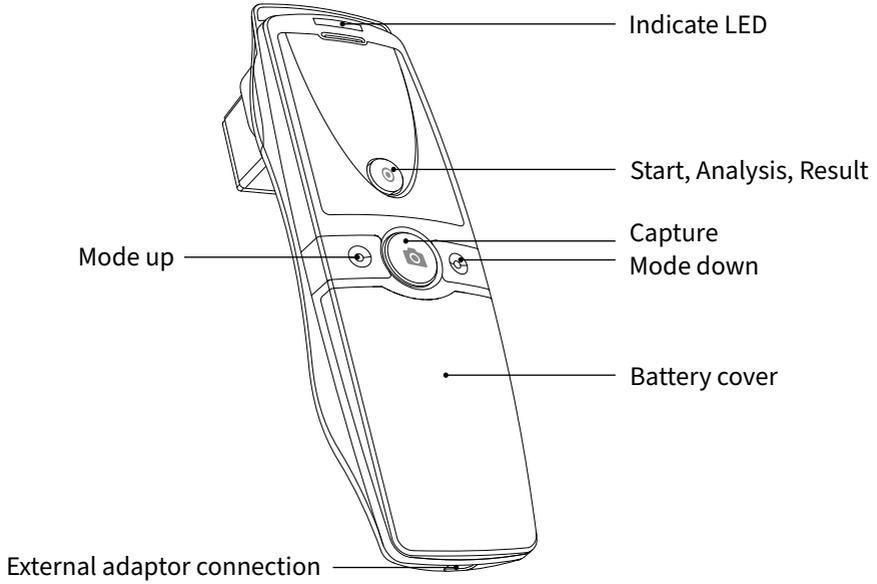

H/W Parts

Settings

Insert the battery

- 1 Open the battery cover by pushing it down with finger.
- 2 Insert the battery and gently press the battery into place.
- 3 Close the cover.

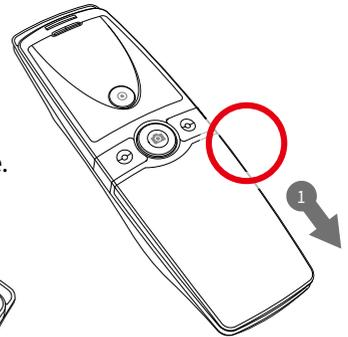
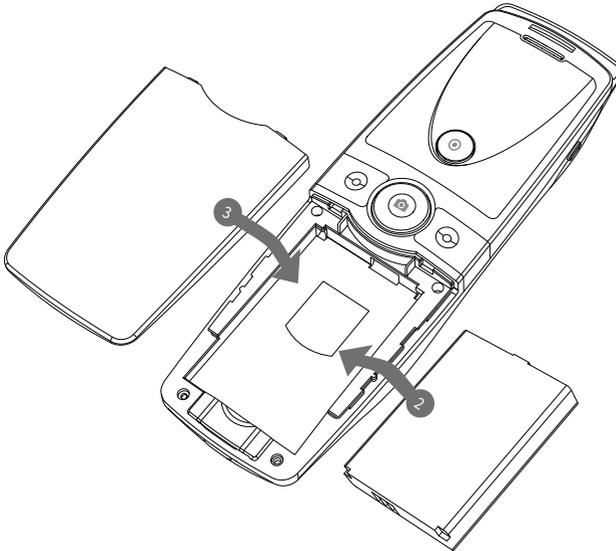

To turn on the power

- 1 Press and hold "power" button.
- 2 "Indicate LED" starts twinkling in blue light.
When it stops, the device is ready to use.

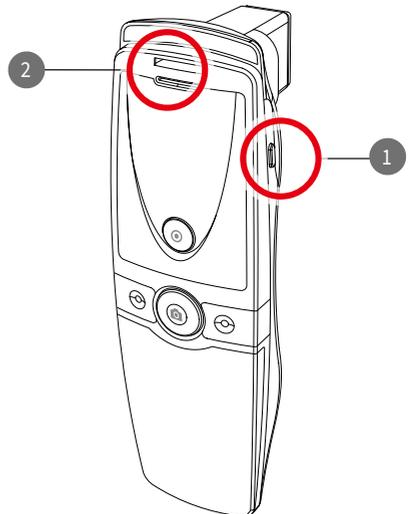

To turn off the power

- 1 Press and hold "power" button.
- 2 "Indicate LED" will be turned off.

H/W Parts

Settings

Charger can be used for American type & European type.
The default is European type .

- 1 Push the plug up.

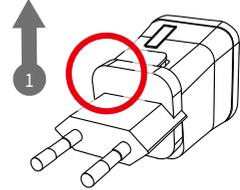

- 2 Then 220V European type is disassembled and you can see the 110V-220V American type inside of the charger.

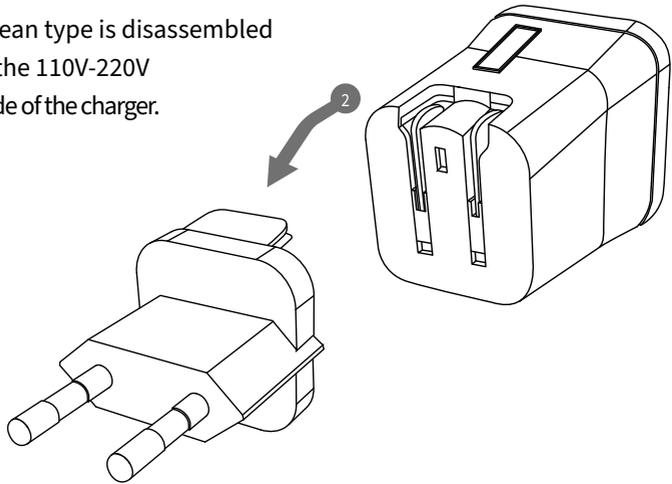

- 3 Choose the one you want to use and connect USB cable in adaptor.

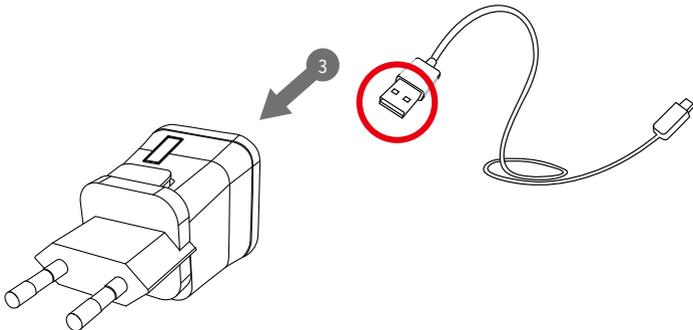

H/W Parts

Battery / Light Functions

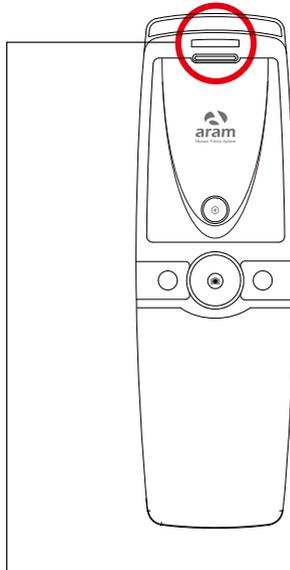

Battery / Light Functions

CAMERA POSITON	STATUS	LED	
In use	While Turning it on	Flashing blue light	● ●
In use	Connected	Blue light	●
In use	Low Battery	Flashing Red/blue light	● ●
In use	While turning it off	Flashing Red light	● ●
Plugged to the base	Charging	Red light	●
Plugged to the base	Fully charged (140 minutes)	Blue light	●

System Settings

Download & Install

PC User

- 1 Go to link on the browser as below.
<http://www.aramhuvis.com/downloads>
- 2 Install the program.

Tablet device or Smartphone user

- 1 iOS : Go to "App Store" and search "Solutionist" to download the program.
- 2 Android : Go to "Google Play Store" and download it.

System Settings

How to connect with program

- 1 First of all, check the Wi-Fi name and password which is described at back side of battery cover.
- 2 Wi-Fi name & password must be same and the format is "API_XXXX".
- 3 Turn on the device.
- 4 While turning on the device, prepare PC, Tablet, Smartphone to run the S/W.
- 5 Once "API" device is turned on, please go to network setting to set up the Wi-Fi connection.
- 6 Among Wi-Fi lists, find "API_XXXX" and select it.
- 7 When above code is connected, run the program "Solutionist".
- 8 To check working properly, please check the program and see the left below side.
- 9 If it is correctly set up, you can see the orange light of Wi-Fi signal.

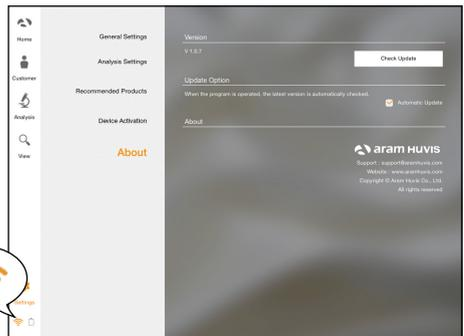
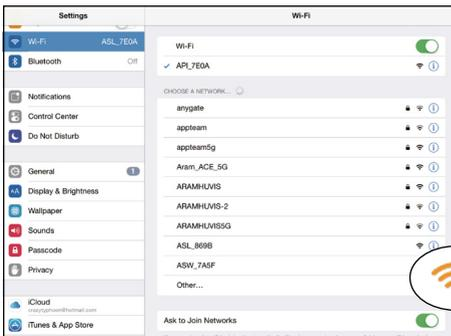
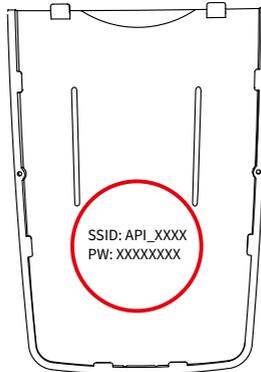

System Settings

Wi-Fi Combo

Wi-Fi Combo

- It means user could use device and internet at the same time.
- With this function, user can send an email after analysis immediately.

How to use?

- 1 The device has AP(API_XXXX) to be connected with the program “Solutionist” by Wi-Fi.
- 2 First of all, connect the device to AP to use it with “Solutionist”.
- 3 Run “Solutionist”.

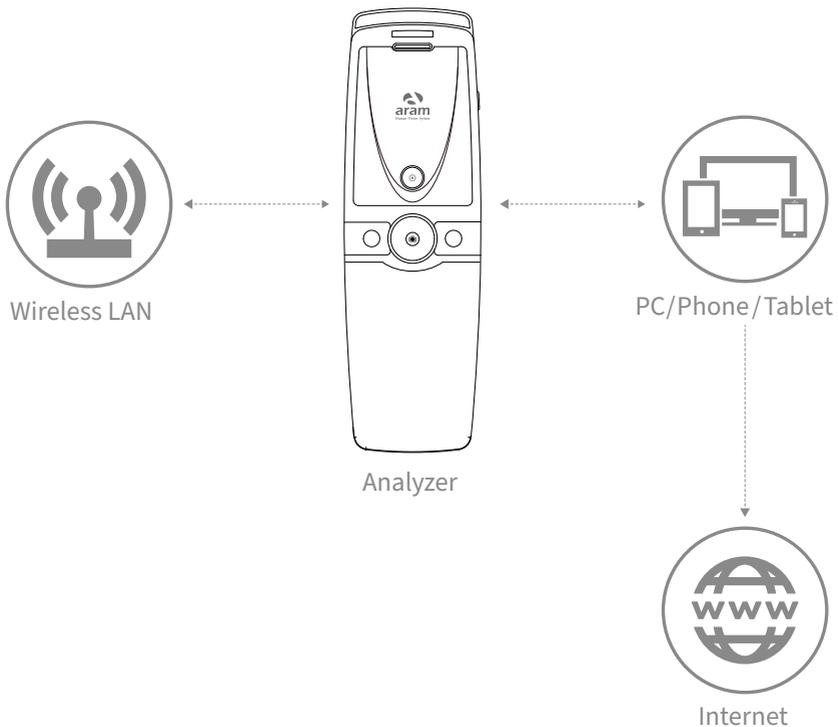

System Settings

Wi-Fi Combo

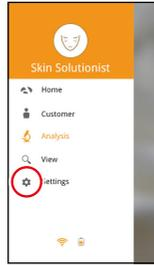

1 Touch Settings.

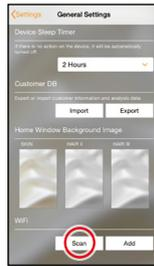
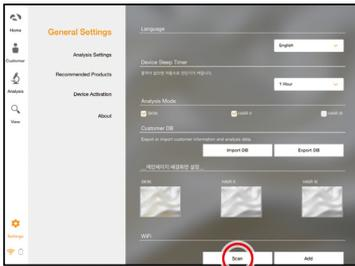

2 In "General Settings", go to "Wi-Fi" and touch "Scan" button.

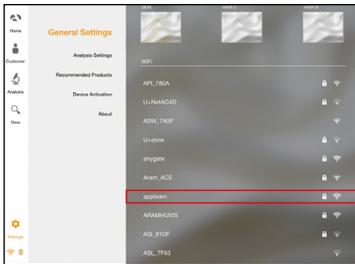

3 The available Wi-Fi lists appear. Among them, please choose the best signal Wi-Fi to connect it.

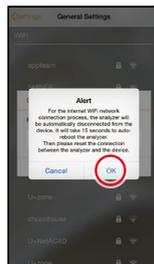
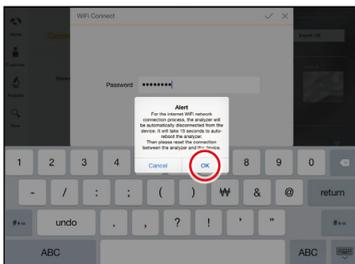

4 During connect it, you can see the message saying that API device will be automatically disconnected and reboot. Please touch "OK" button.

System Settings

Wi-Fi Combo

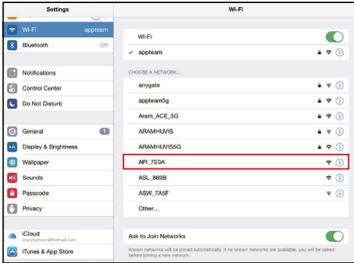

- 1 When Wi-Fi is connected, please go to “Settings” page to set up the Wi-Fi connection.
You can see now the Wi-Fi is connected. Please turn it off and connect with device AP code. (API_XXXX).

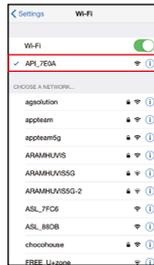
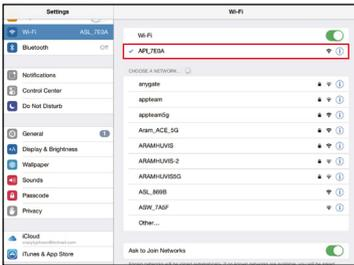

- 2 The analyzer is connected with AP code.



- 3 Then, run “Solutionist” program.

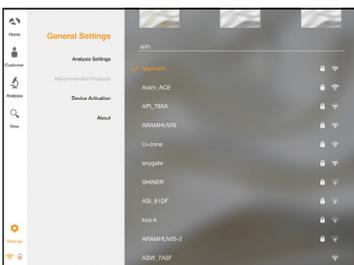

- 4 Then go to the settings again. The selected AP will be checked as left. The Wi-Fi combo is done.

Program Settings

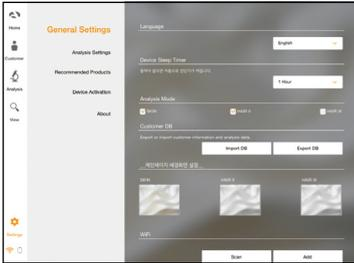

- 1 General Settings**
 Change the language, analysis mode and etc.

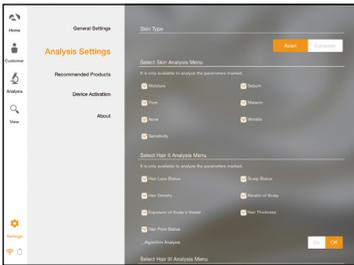

- 2 Analysis Settings**
 Set up the skin type and analysis parameter.

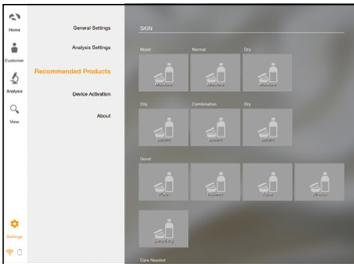

- 3 Recommended Products**
 Available for each analysis result.

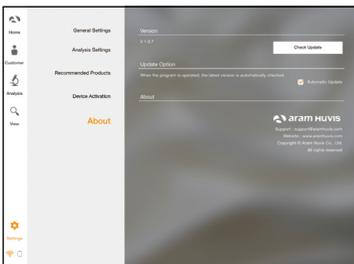

- 4 About**
 Check the current version and update is available in Wi-Fi connection.

Program Settings

Device Certification



- 1 Solutionist program includes three programs.
But when you start “Solutionist” program with API-100 device you can see the pop message saying that the program is compatible with only “SKIN” device.
Touch “OK” button.

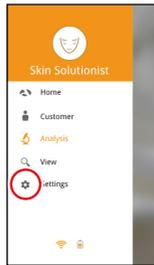

- 2 Then you will see now only “SKIN” program is activated.
On main menu, touch “Settings”.

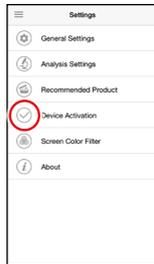
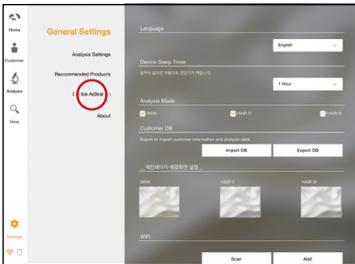

- 3 Among the menu, please select “Device Activation”.

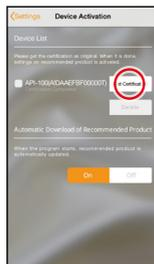
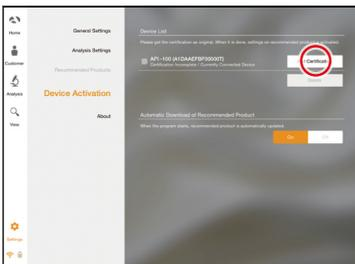

- 4 There is a device model name with serial code.
Please touch “Get Certification” to register the device in program.

Program Settings

Device Certification

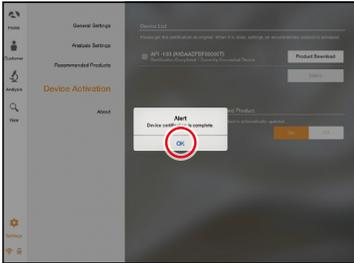

- 5 Device certification is complete. Please touch “OK” button.

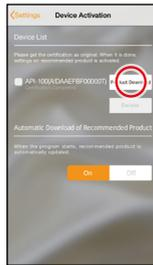
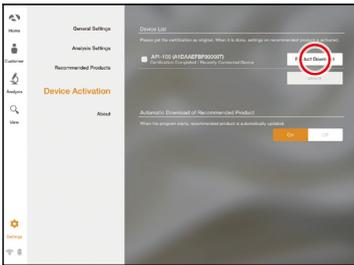

- 6 When it is done, you could touch “Product Download” button to load in server.

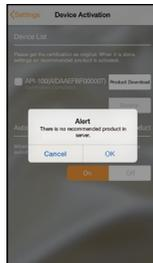
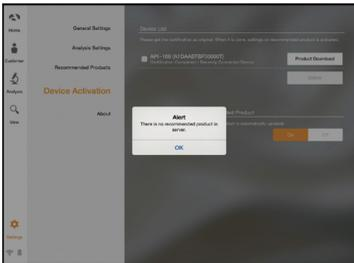

- 7 If you have the recommended product data in server, the product will be downloaded by clicking “Product download”. If you do not have the recommended product data, you can see the message as left image.

Application

Start Analysis

① Touch "Analysis" to start.

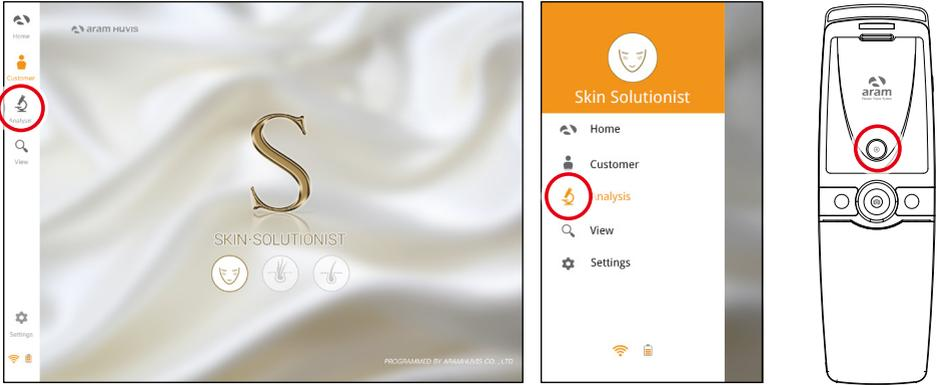

Remote Control (Only Tablet)

- ① During analysis, you can control the device in "Solutionist" program.
- ② In screen, touch "Control Menu On" to activate "Remote".
- ③ You can make use of this function in all analysis pages.

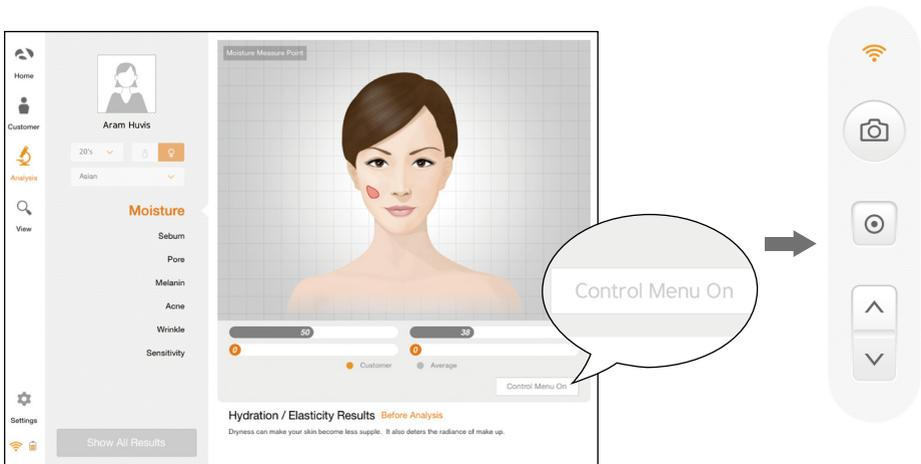

Application CRM

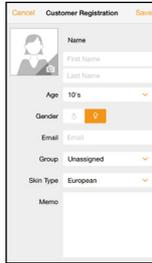
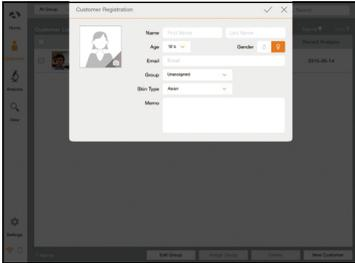

- 1 Input the information.
- full name, email address, gender and age group

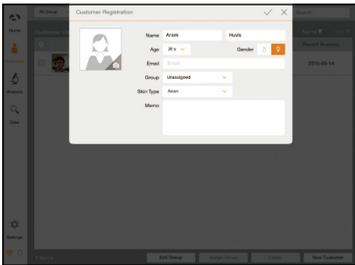

- 2 Take picture of customer's face with built-in camera or use the picture you already have in device.

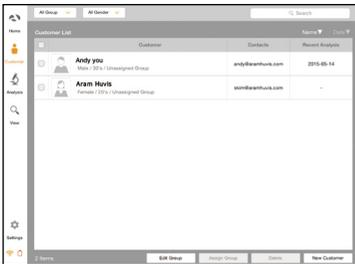

- 3 Among the customer lists, select the client to check or start analysis.

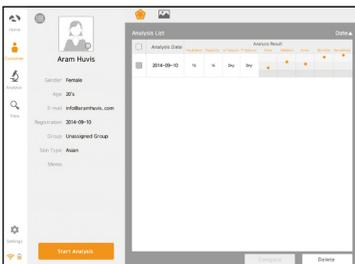

- 4 Check the customer information and analysis result list.

Application

Moisture



- 1 Press "capture" button and when you hear "beep" sound, please put the sensor on your skin and wait until you hear "beep" sound again.

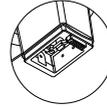

Moisture sensor



- 2 The result will appear. To analyze the next step, touch the below button.



Application

Sebum

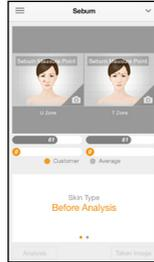
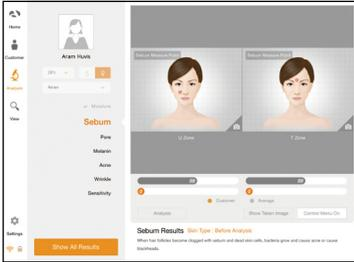

- Put the sebum paper onto the U-zone on the cheek then press it for 2~3 seconds.



U-zone

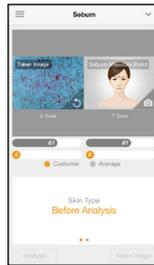
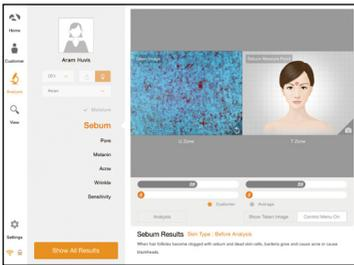

- Place camera on the pink area and take picture. (U-zone)

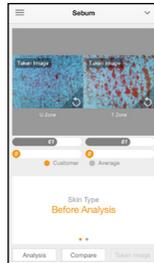
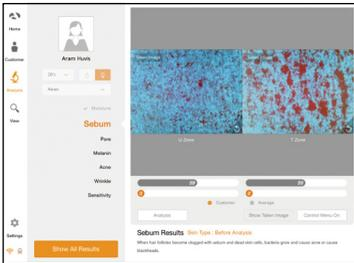

- Put the sebum paper onto the T-zone on face, then press it for 2~3 seconds. Place camera on the pink area and take picture. (T-zone)

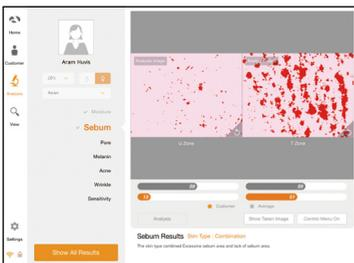

- The result will appear. To analyze the next step, touch the below button.



Application

Pore

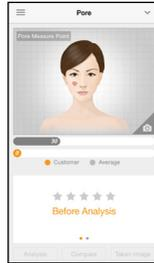
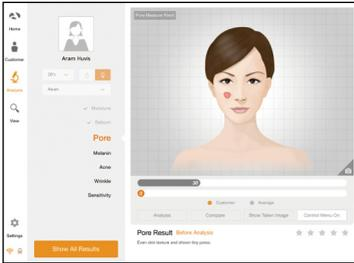

1 Touch button to activate camera mode.

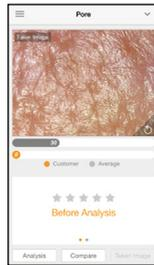
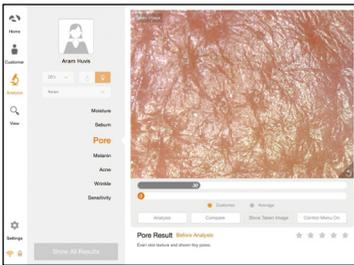

2 Put the camera onto the skin and touch button to capture the image. Then touch button to analyze it.

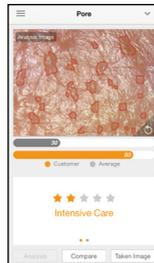
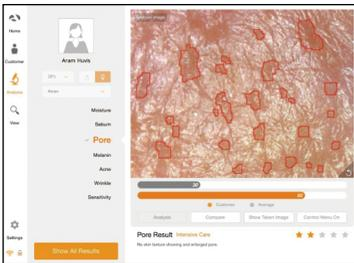

3 The result will appear. Touch "Compare" button to check the sample images as 4.



4 Compare your image with 3 sample images.

- Good
- Normal
- Bad

Application

Melanin

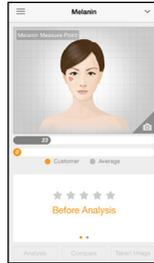
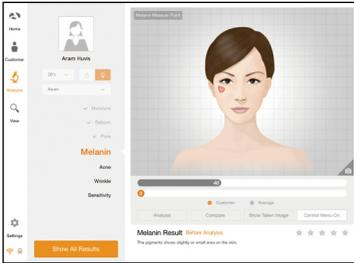

- 1 Touch  button to activate camera mode.

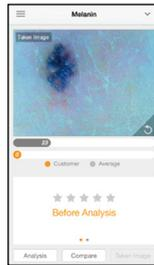
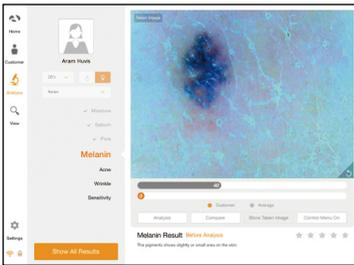

- 2 Put the camera onto the skin and touch  button to capture the image. Then touch  button to analyze it.

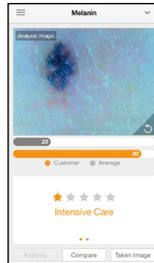
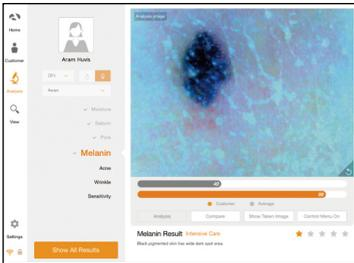

- 3 The result will appear. Touch "Compare" button to check the sample images as 4.
- To analyze the next step, touch the below button.

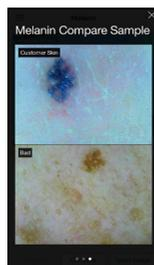
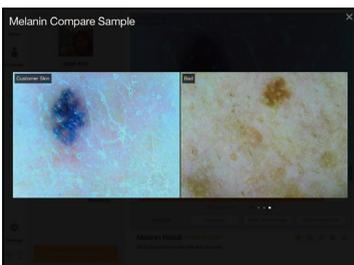

- 4 Compare your image with 3 sample images.

- Good
- Normal
- Bad

Application

Cleanliness of Pore

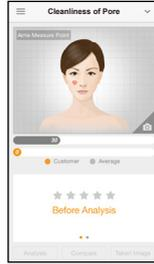

- 1 Touch  button to activate camera mode.

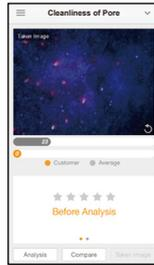
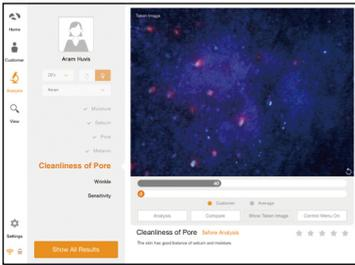

- 2 Put the camera onto the skin and touch  button to capture the image. Then touch  button to analyze it.

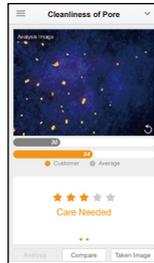
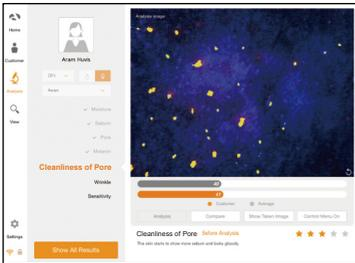

- 3 The result will appear. Touch "Compare" to check the sample images as **4**. To analyze the next step, touch the below button.

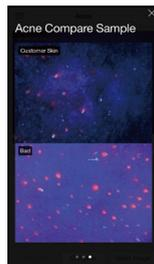
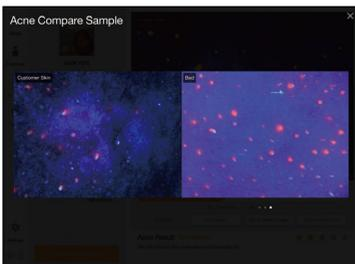

- 4 Compare your image with 3 sample images.

- Good
- Normal
- Bad

Application

Wrinkle

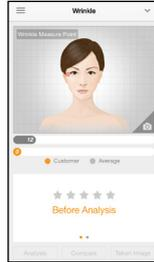

- 1 Touch  button to activate camera mode.

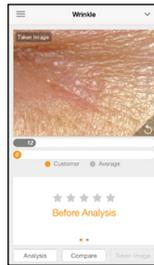
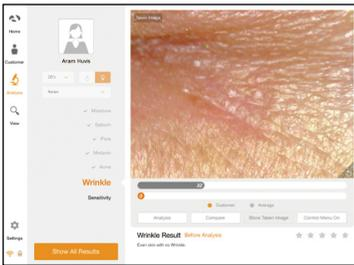

- 2 Put the camera onto the skin and touch  button to capture the image. Then touch  button to analyze it.

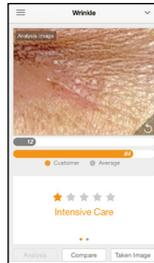
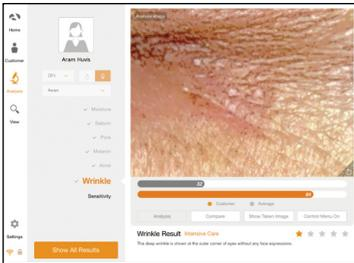

- 3 The result will appear. Touch "Compare" button to check the sample images as 4.
- To analyze the next step, touch the below button.

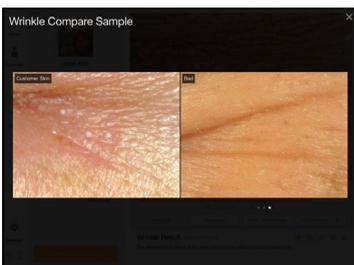

- 4 Compare your image with 3 sample images.

- Good
- Normal
- Bad

Application

Sensitivity

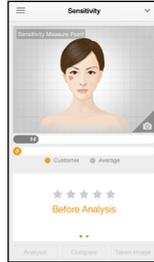

- 1 Touch  button to activate camera mode.

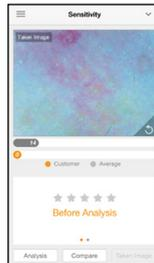
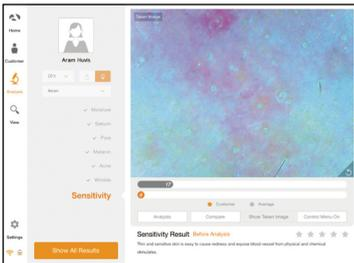

- 2 Put the camera onto the skin and touch  button to capture the image. Then touch  button to analyze it.

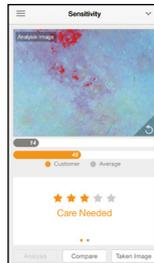
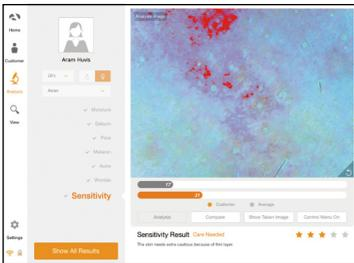

- 3 The result will appear. Touch "Compare" button to check the sample images as 4. To check all the results, touch "Show All Results" or the below button

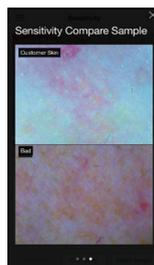
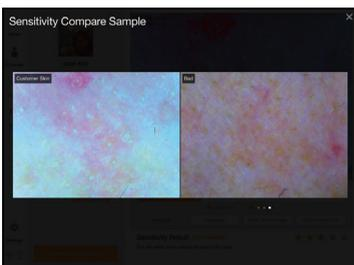

- 4 Compare your image with 3 sample images.

- Good
- Normal
- Bad

Application Summary



1 Check the result.

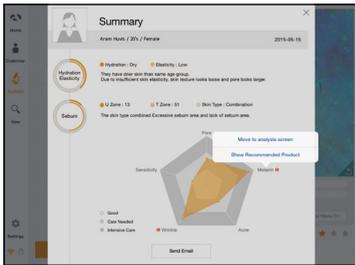

2 Touch **+** button or each parameter's name on pentagon graph. Once you select "Show Recommended Product", product image will pop up as **3**.



3 Available to check product image.

Application

View Mode



- 1 In view mode, it is able to take pictures with capture button in many times.

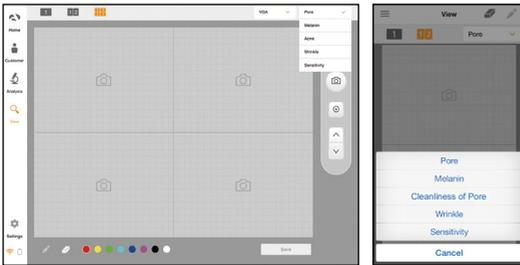

- 2 The user can select analysis parameter to take picture.

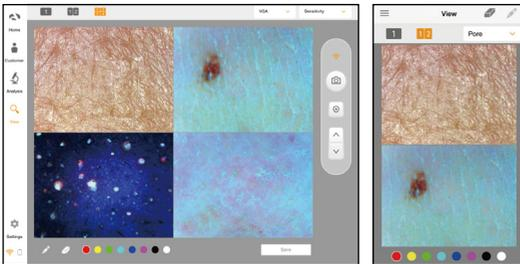

- 3 In one screen, you can see 4 different images maximum.

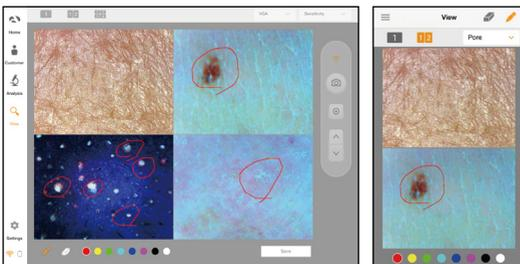

- 4 The user can mark the defect or concern according to the image with note function.

Warranty

- ① The product undergoes strict quality management and inspection process before production and introduction to market.
- ② In case of functional or operational defect occurring under normal condition of use within 10 days after purchase, we will repair it for free or replace in new product.
- ③ When this product goes out under the normal use, we will repair it free of charge under warranty.
- ④ Please keep the warranty card when you ask for repair service.
- ⑤ Customer needs to pay repair charge after warranty runs out.
- ⑥ For this product, warranty period is 14 months from the Invoice date.

⑦ Cost

Within warranty : Sending delivery(Buyer), repair cost and returning delivery(Aram).

- If the product is broken by user's fault, repair cost could be charged.

After warranty : Sending delivery and repair cost(Buyer), returning delivery(Aram)

⑧ How to send :

- As sending a present from person to person by EMS or FEDEX.

(Do not write the company name)

- Total value should be under US \$99.(Write non-commercial value)

Warranty

Service request form			
Date of purchase	/	/	Company
Contact person			
Address :			
Tel :			
Product name, serial no :			
Problems :			

Shipping address:

560, Dunchon-daero, Jungwon-gu, Seongnam-si, Gyeonggi-do, 13230, Rep. of KOREA

E-mail : support@aramhuvis.com

Tel : +82 70 4687 1712 / Fax : +82 31 732 6330

MEMO

MEMO

MEMO



HEAD OFFICE

#401~402 Bundang Seoul National University Hospital Health Care Innovation Park, 172, Dolma-ro, Bundang-gu, Seongnam-si, Gyeonggi-do, 13605 Rep. Korea

PRODUCTION DIVISION & FACTORY

#909 Byucksan Technopia, 560, Dunchon-daero, Jungwon-gu, Seongnam-si, Gyeonggi-do, 13230 Rep. Korea

Tel: 070-4687-1712 / Fax: 031-732-6330 / Email: info@aramhuvis.com
<http://www.aramhuvis.com>